

Tiba

for Development Storage
& Handling Equipments

HR
HydroRacks



Profile & Goals of the Company:

 *Supplying the market with products that are safe and effective and appropriate costs.*

 *Availability of modern handling equipment and storage Technology.*

 *Suggest to the customer's Appropriate Systems.*

 *Provide warranties and after-sales service.*



Upright Frame →

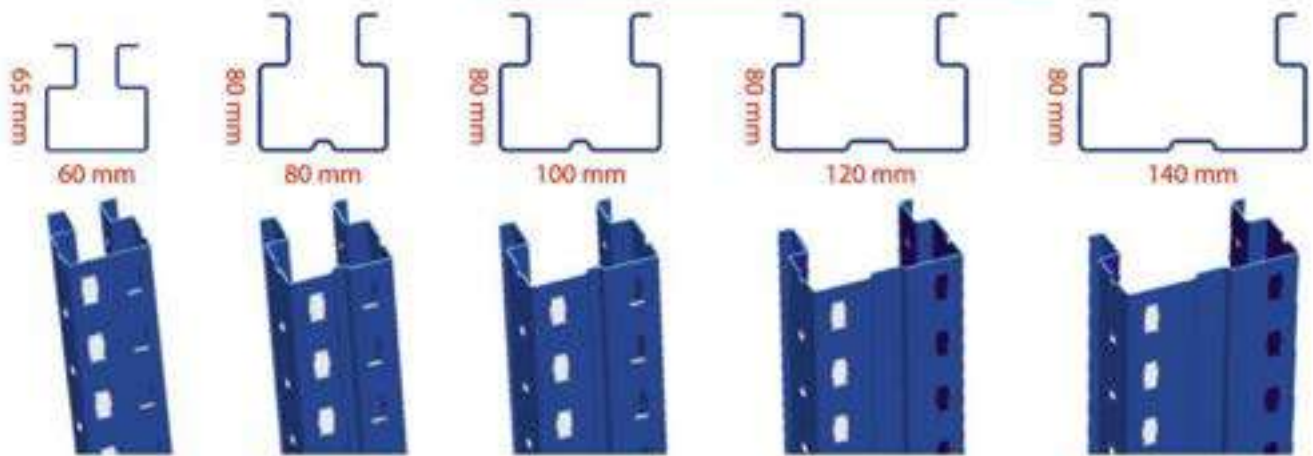

Beams →

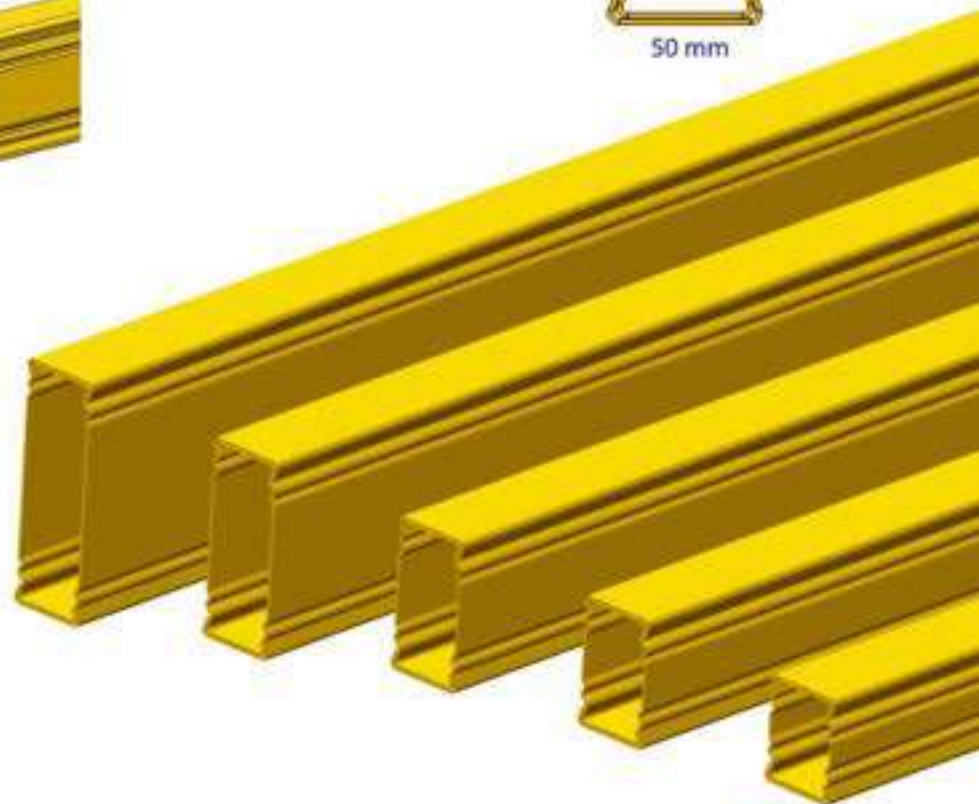
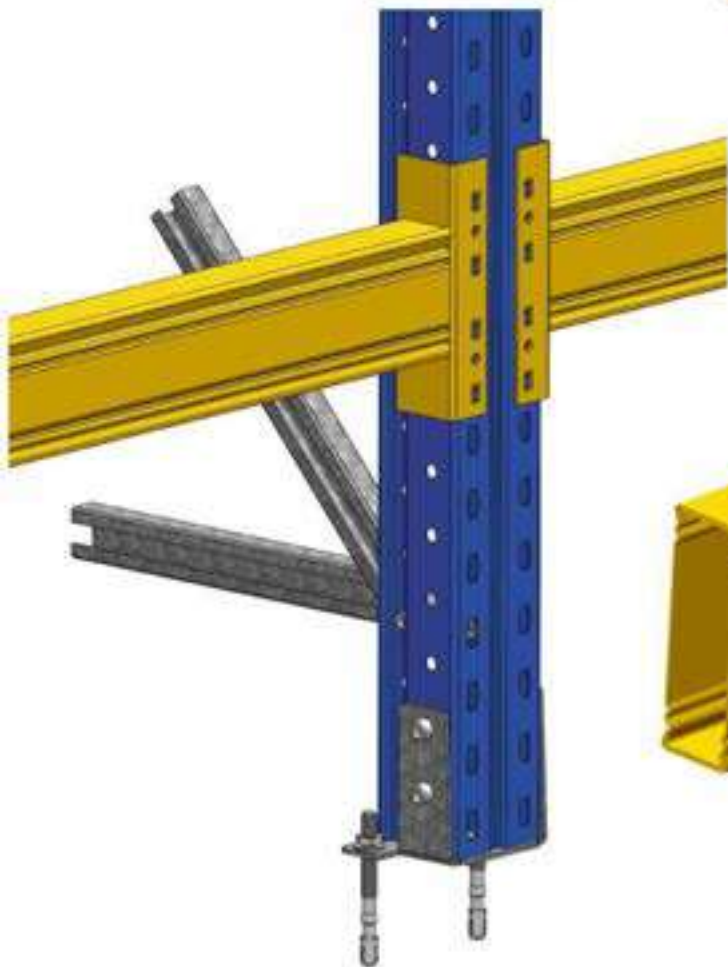
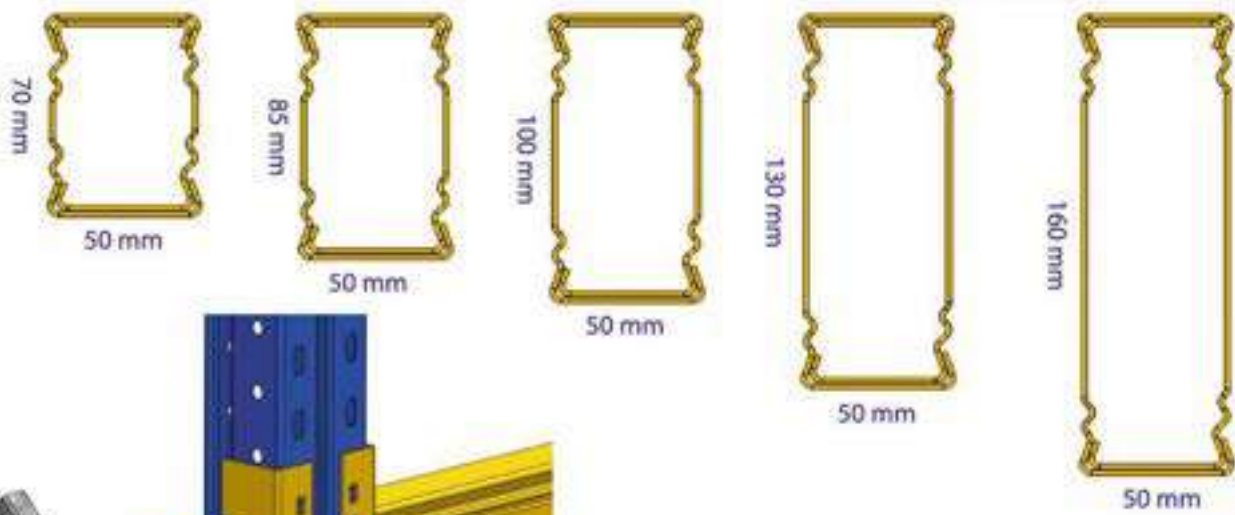

Selective Pallet



- § The universal system for **direct access** to each pallet.
- § It **maximises space** available for storage.
- § Can be **adapted** to any size or weight of pallet.





Very Narrow Aisle





Radio-Shuttle ➔

- § Allows accumulation storage of different references by level.
- § Efficient and very accurate system of loading and unloading.
- § Reduces the time of the unloading of stored goods in a channel.
- § Ideal for cold storage warehouses.



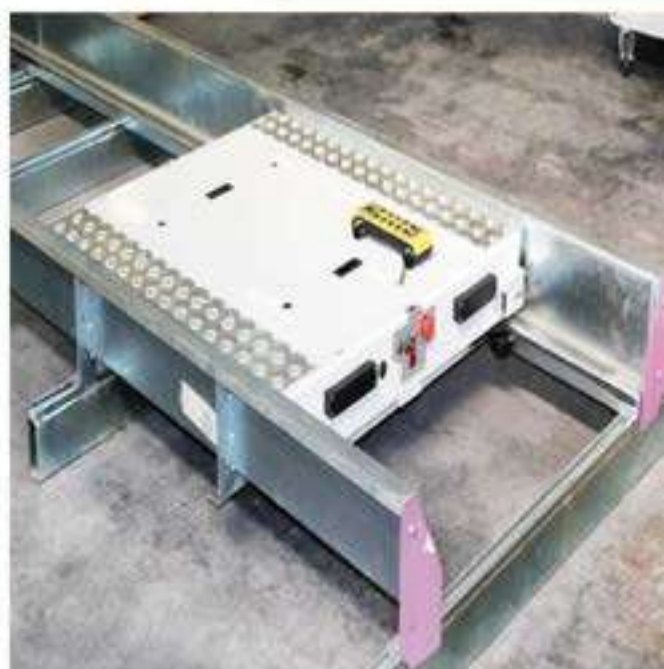

Drive-In / Drive-Thru

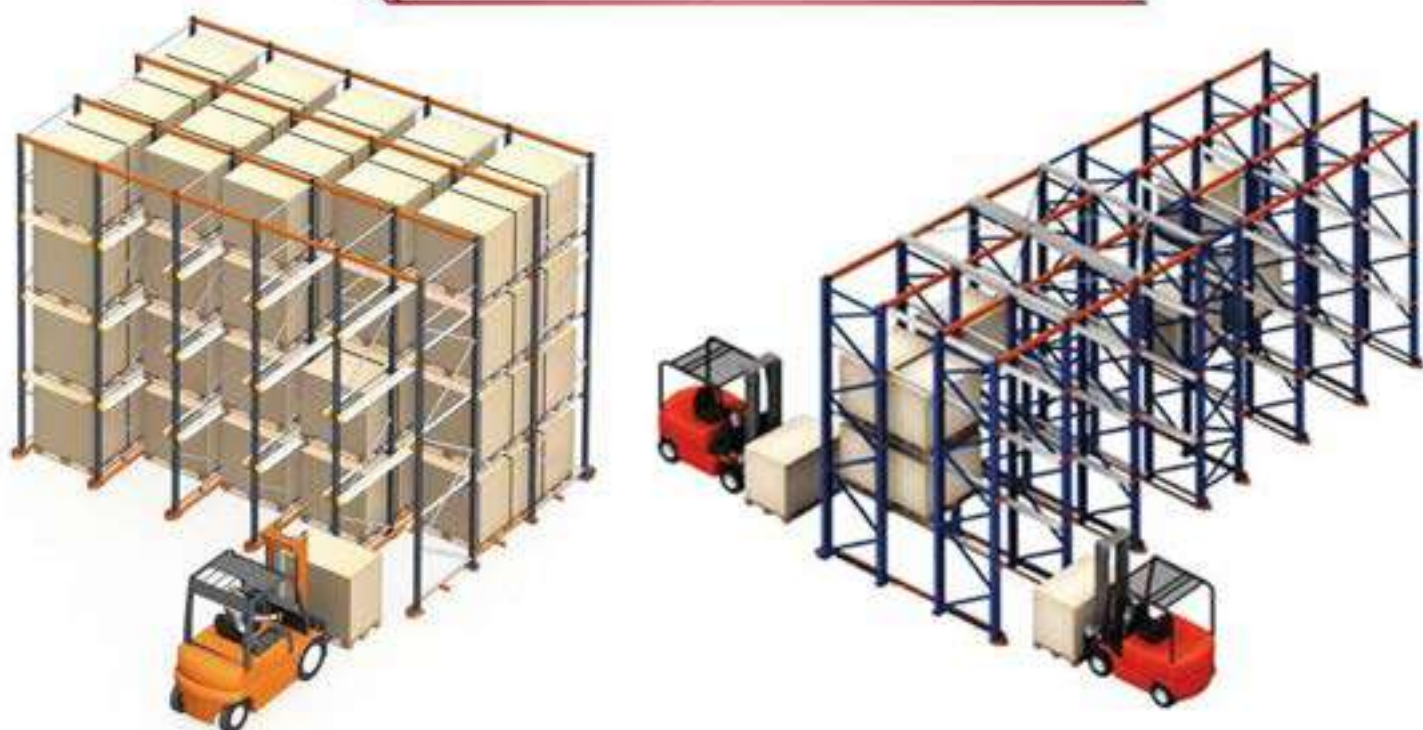

Long Span



Mobile Rack →

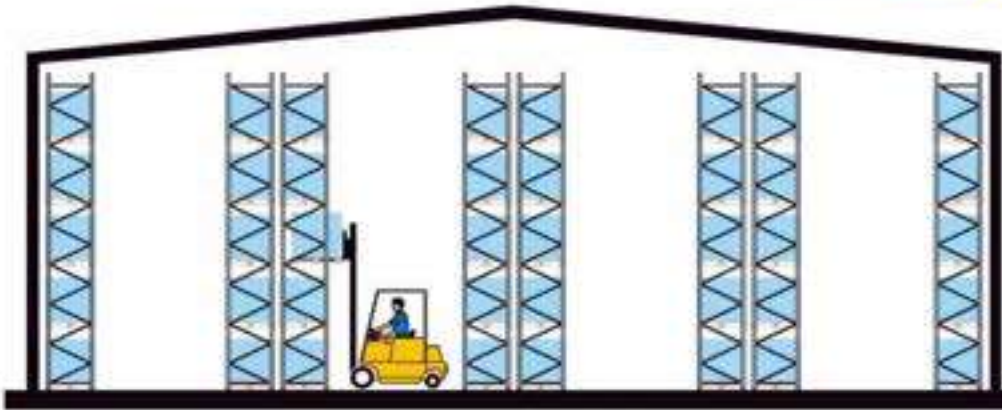

A

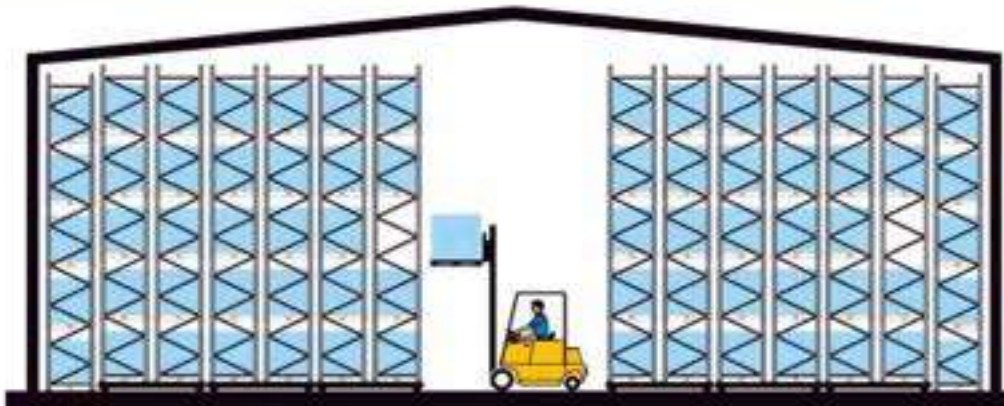

B

Mobile Shelf >







Self-supporting warehouse advantages

- § Large storage capacity at high altitude.
- § Execution time and cost maximisation without any need for prior building construction.
- § Control and security of the stored products.

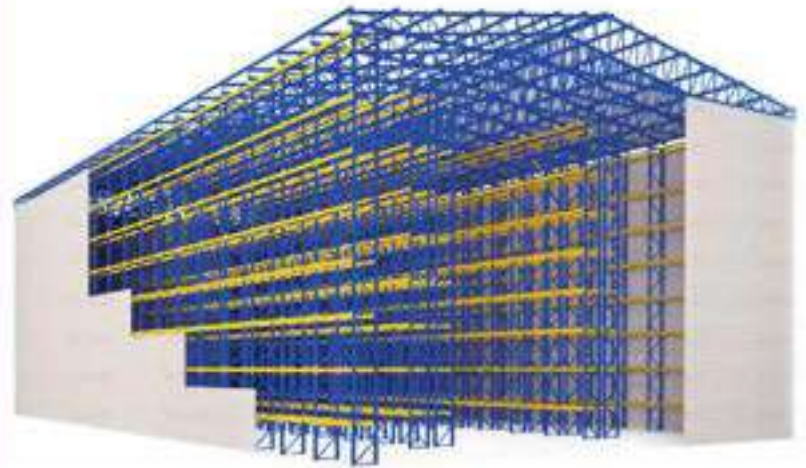

Mezzanine Floors >

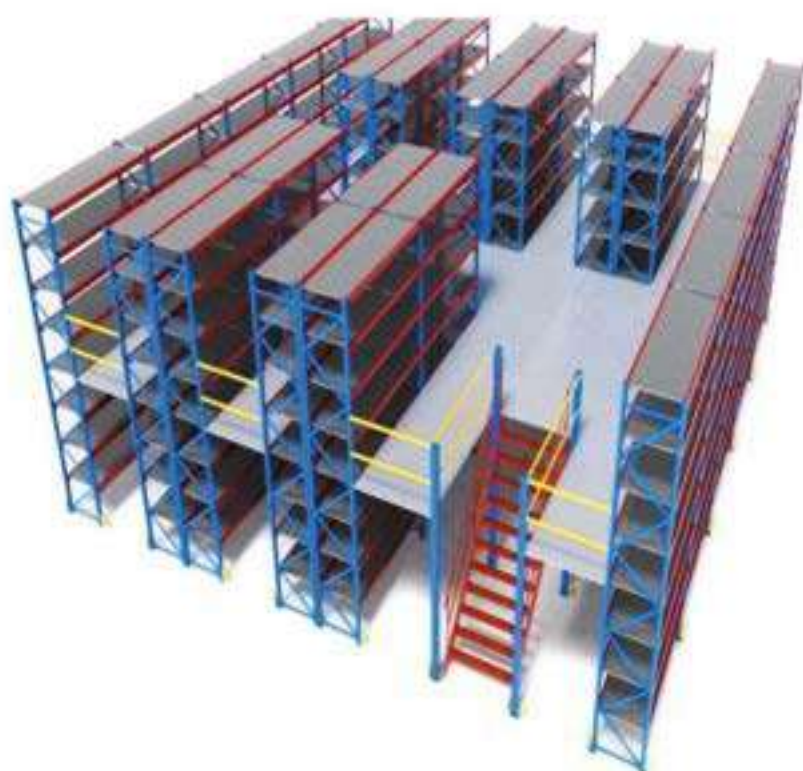

Raised Floors

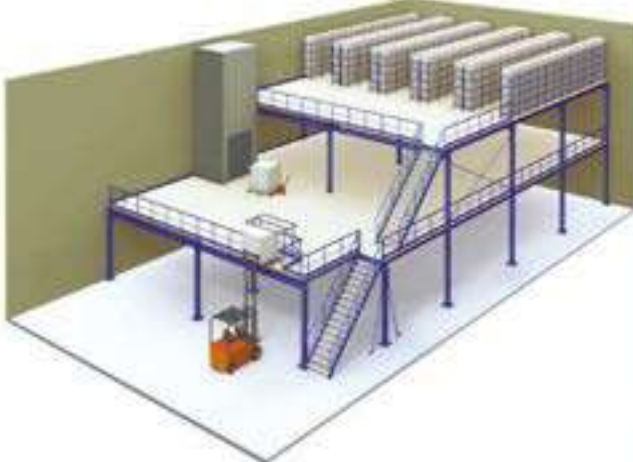

Carton Flow



It doesn't matter whether you want to feed fast movers in trays, cartons or hard plastic totes to the stock-picking zone in a First-In-First-Out configuration, our Carton Flow system guides all the items into the correct lanes.

With a wide range of configurations and components it is possible to implement often even the most complex of storage and stock-picking set-ups. The Carton Flow system is easy to assemble and maintenance-free and pays for itself in next to no time.



Cantilever Racking >



§ Cantilever racking is ideal for the storage of long loads such as beams, profiles, pipes, timber, etc.



Light Racks →



- § New compact design.
- § Extremely easy, boltless assembly.
- § Modular system permitting a wide variety of combinations.

Lockers ➤



Wire Shelf →

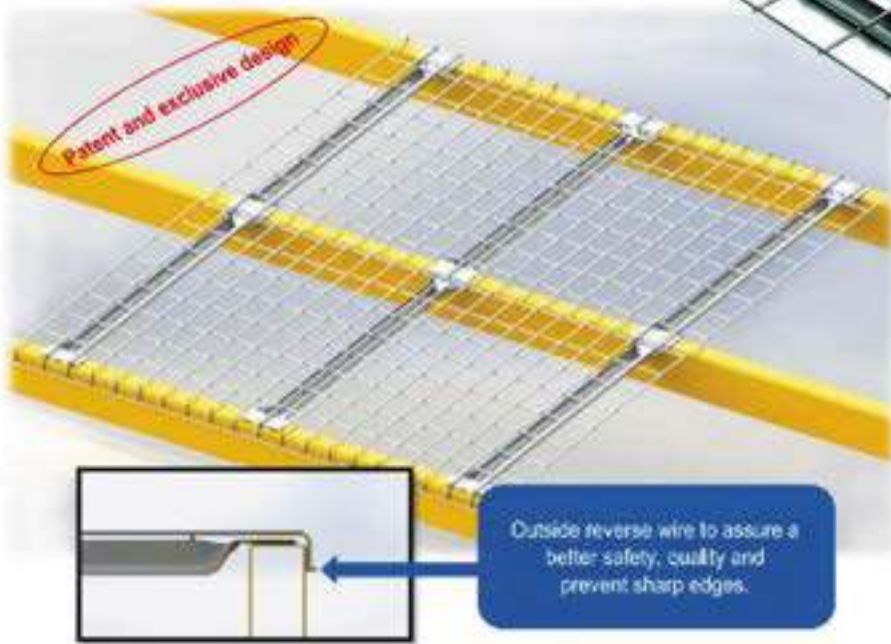
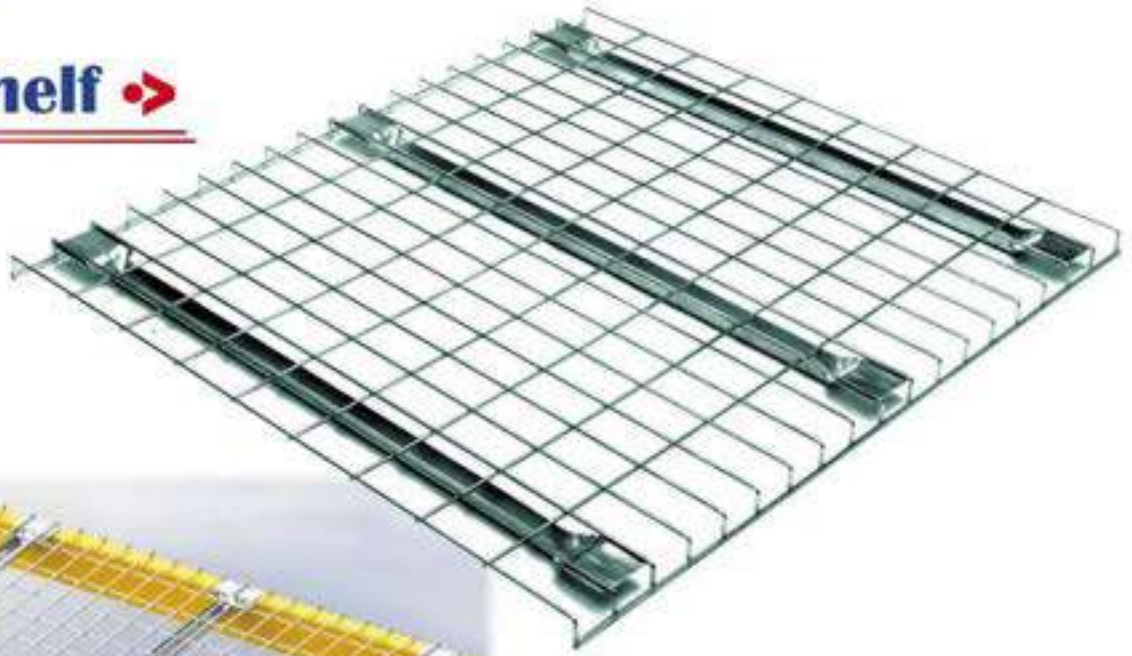

Scissor Lift →



Hand Pallet →



Our Customers



TOSHIBA



General Motors



DELTA TEXTILE
BULGARIA LTD.



عبد العزيز السلاب
ABDEL AZIZ EL SALLAB



بنك مصر
BANQUE MISR

WORKING TOGETHER FOR PROSPERITY



طيبة

لتطوير المخازن ومعدات المناولة



Head Office: 1 El-Dobat Emtedad, Bilbeis Desert Road, El-Salam City, Cairo, EGYPT

Factory: 10th of Ramadan, Egypt

Tel.: 0100 19 25 610 - 010 000 41 972

sales@hydro-racks.com - ashraf.tiba@gmail.com

www.hydro-racks.com